

# PRETTY LITTLE THINGS



## Dinosaurs

KNIT, EMBROIDER AND CROCHET



# Stevie Stegosaurus



↗  
*Thanks to clever shaping,  
the body is made from one  
piece folded in half!*



## DINOSAURS

Some of my fondest childhood memories include trips to see the dinosaur skeletons and fossils in the Natural History Museum in London. It was always a great adventure to travel there, and after each visit, my head would be full of stories and facts about a time far from our own. I'm still as intrigued as ever by these wonderful creatures, and hope to pass on some of my sense of awe for the animals that used to roam our planet to the children of today. Designed for the little ones in your life, I hope that the ROAR-some makes in this issue inspire creativity and open the door to a whole world of wonder.

Scheepjes Creative Director

*Sunny*

### STEGOSAURUS PRAM GARLAND

By Amanda Berry

#### Gauge/Tension

36 sts and 46 rows to measure 10 x 10cm over st st using 2.25mm needles

#### Measurements

Knitted Dinosaur 7 x 15cm

#### Abbreviations

[ ] number of sts on a given row

**beg** beginning

**k** knit

**k2tog** knit 2 sts together: insert needle kwise into first two sts and knit them together

**kfb** knit front and back to increase by 1 st: insert needle kwise into next st: knit as normal but don't slip st from needle, instead bring needle around to back and knit through back loop of same st

**kwise** knitwise

**p** purl

**pwise** purlwise

**rem** remaining

**rep** repeat(s)

**RS** right side(s)

**ssk** slip slip knit: slip 1 st kwise, slip next st kwise, insert left needle into front of slipped sts and knit them together

**st(s)** stitch(es)

**st st** stocking stitch: RS knit, WS purl

**WS** wrong side(s)

**(...) x times** work the instructions between brackets the *total* number of times stated

#### Pattern Notes

Use knitted cast on throughout. Body is worked in one piece then folded in half to form dinosaur. Scales, Spots and Legs are worked separately and stitched to Body.

Elastic cord is threaded with Dinosaur, silicone beads and teething rings to form garland.

PRETTY LITTLE THINGS



### SHOPPING LIST

Visit your local Scheepjes retailer to purchase all materials listed below, quoting the item numbers where required

### STEGOSAURUS PRAM GARLAND

#### Scheepjes Cotton 8

(100% Cotton: 50g/170m)

**Yarn A:** 723 (sea green) x 1 ball

**Yarn B:** 726 (purple) x 1 ball

**Yarn C:** 502 (white) x 1 ball

2.25mm knitting needles

15 x 14mm Opry hexagonal multicolour silicone beads  
(item no. 64528-AST4)

2 x 20mm Opry round blue silicone beads  
(item no. 64535-183)

2 x 20mm Opry round white silicone beads  
(item no. 64535-009)

2 x 20mm Opry round green silicone beads  
(item no. 64535-433)

1 x 2.5mm Prym elastic cord  
(item no. 971.230)

2 x Opry green silicone dummy clips  
(item no. 64526-433)

2 x 55mm Opry green silicone teething rings  
(item no. 64538-433)

2 x 2-hole cord stoppers  
(item no. 96648-495)

Polyester stuffing  
(item no. 240130-10)

Length of black yarn for eyes

Tapestry needle + pliers to thread beads

# PRETTY LITTLE THINGS



## NOTES

Use this space to write your pattern notes!

## GREAT FOR BABIES!

Opry Silicone Beads, Teething Rings and Dummy Clips are made from **BPA-free silicone**, making them safe for teething babies and children. The Scheepjes Cotton 8 yarn also carries the **OEKO-TEX Standard 100** and **EN71-3** certifications, further guaranteeing suitability for use in items made for little ones.

Made a Pretty Little Thing from one of our issues?  
We'd love to see it! Share on social media using  
**#ScheepjesPrettyLittleThings**

## Instructions

### BODY

Using Yarn A, cast on 16 sts.

Beg with a k row, work 2 rows in st st. [16 sts]

**Row 3 (RS)** K1, kfb, k to last 2 sts, kfb, k1.

[18 sts]

**Row 4 (WS)** Purl.

Rep Rows 3-4 five more times. [28 sts]

**Rows 15-18** Work 4 rows in st st.

**Row 19** Rep Row 3. [30 sts]

**Row 20** Cast on 5 sts at beg of row, p to end.

[35 sts]

Rep Rows 3-4 twice more. [39 sts]

**Row 25** Cast on 6 sts at beg of row, k to end.

[45 sts]

**Row 26** Purl.

**Rows 27-28** Rep Rows 25-26. [51 sts]

**Rows 29-30** Work 2 rows in st st.

**Row 31** K to last 3 sts, k2tog, k1. [50 sts]

**Row 32** Purl.

**Row 33-34** Rep Rows 31-32. [49 sts]

**Row 35** K to last 2 sts, kfb, k1. [50 sts]

**Row 36** Purl.

**Rows 37-38** Rep Rows 35-36. [51 sts]

**Rows 39-40** Work 2 rows in st st.

**Row 41** Cast off 6 sts, k to end. [45 sts]

**Row 42** Purl.

**Rows 43-44** Rep Rows 41-42. [39 sts]

**Row 45** K1, ssk, k to last 3 sts, k2tog, k1. [37 sts]

**Row 46** Purl.

**Row 47** Rep Row 45. [35 sts]

**Row 48** Cast off 5 sts pwise, p to end. [30 sts]

**Rows 49-50** Rep Rows 45-46. [28 sts]

**Rows 51-54** Work 4 rows in st st.

Rep Rows 45-46 six more times. [16 sts]

Cast off.

### SPOT (MAKE 4)

Using Yarn C, cast on 16 sts.

**Row 1 (WS)** Knit.

**Row 2 (RS)** (K2tog) 8 times. [8 sts]

Break yarn, thread through rem sts, pull tight.

### SCALE (MAKE 5)

Using Yarn B, cast on 8 sts.

**Rows 1-4** Knit.

**Row 5 (RS)** K2tog, k to end. [7 sts]

**Rows 6-10** Rep Row 5 a further five times. [2 sts]

Break yarn, thread through rem sts, pull tight.

### LEG (MAKE 4)

Using Yarn A, cast on 12 sts.

**Rows 1-12** Beg with a k row, work 12 rows in st st.

Cast off.

### ASSEMBLY

Use photo as guide. Fold Body in half, join sides, stuffing as you close. Embroider eyes with black yarn, adding highlight st with Yarn C. Stitch Scales to back, then join side edges of Spots to form circle, stitch to Body. Fold Legs in half, join cast-on/cast-off edges, gather sides at top and bottom, stitch to secure. Do not stuff Legs and join to sides of Body. Weave in all ends. Thread Dinosaur, beads and rings onto elastic, passing through top of Dinosaur Body, place stoppers and clips at each end, cut elastic.



# Brooklyn Brontosaurus



*Discover lots of new  
stitches with this  
pretty little make!*

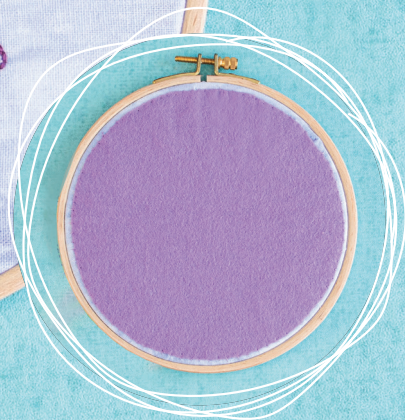

## EMBROIDERY STITCHES

Use the illustrations below as a guide to working the stitches in the Brontosaurus Embroidery project. See Pattern Notes if you need more help.



*satin stitch*

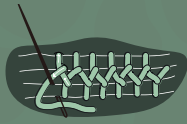

*Cretan stitch*

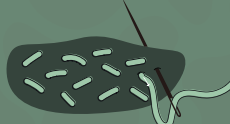

*seed stitch*



*herringbone  
stitch*

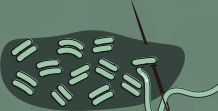

*double seed  
stitch*

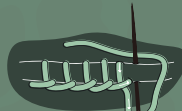

*buttonhole  
stitch*



*French knot*



*running stitch*



*backstitch*



*chain stitch*



*slanted Cretan  
stitch*



*detached chain  
stitch*



*lazy daisy stitch*

## BRONTOSAURUS EMBROIDERY



By Liz Barraclough

### Measurements

15.5cm diameter

### Abbreviations

RS right side

st(s) stitch(es)

### Pattern Notes

Brontosaurus is worked using various sts: see Schematic 1 for st placement and colours, and Embroidery Stitches feature for working sts.

For written stitch instructions, visit:

[bit.ly/simys-embroidery-tutorial](http://bit.ly/simys-embroidery-tutorial). Separate all threads and use number of strands as indicated.

### Instructions

#### PREPARE FABRIC

**Step 1** Tape design to window or lightbox, position fabric on top with RS facing up and trace design centrally using water-soluble pen.

**Step 2** With traced design facing up, mount fabric into embroidery hoop and screw tight to secure, making sure not to distort image.

#### EMBROIDERY

**Step 3** Using three strands of Colour A and following purple lines, use back st for mouth, sleepy eye, toe and outline. Work broken lines in running st and nostril with small French knot (wrap yarn around needle once only).



**Step 4** Using two strands of Colour B and following green lines, use back st to create stem and detached chain sts for leaves.

**Step 5** Using two strands of Colour C and following lilac lines, fill in toes with satin st, work slanted Cretan sts at middle of rear paw and along spine and work French knots at belly. Using one strand of Colour C, work French knots at back of neck.

**Step 6** Using two strands of Colour D and following pink lines, work Cretan sts at neck and back of rear paw, and work buttonhole sts at middle of front paw. Using one strand of Colour D, work lazy daisy sts at neck.

**Step 7** Using two strands of Colour E and following blue lines, work double seed sts at

bottom of all paws and single seed sts at back of rear paw and tail, work herringbone sts at front of rear paw and at end of tail, work chain sts on front paw and rear paw, and work buttonhole sts at belly and inner tail. Using one strand of Colour E, work lazy daisy sts at middle of tail.





## TO FINISH

Dab work with damp sponge to remove all pen marks. Trim excess fabric to 5cm to neaten back of work, and apply Fray Check around cut edge. Once dry, use sewing thread to work running sts around edge and pull to gather. Cut circle of felt to same size as inner hoop and whip st to gathered fabric for backing.

## Schematic 1: Embroidery Template

Photocopy Brontosaurus at 200%

### Key

- |   |  |
|---|--|
|  Colour A                |  lazy daisy stitch    |
|  Colour B                |  double seed stitch   |
|  Colour C                |  standard seed stitch |
|  Colour D                |  herringbone stitch   |
|  Colour E               |  chain stitch        |
|  back stitch           |  |
|  running stitch        |  |
|  French knot           |  |
|  detached chain stitch |  |
|  satin stitch          |  |
|  slanted Cretan stitch |  |
|  Cretan stitch         |  |
|  buttonhole stitch     |  |



PRETTY LITTLE THINGS



## SHOPPING LIST

Visit your local Scheepjes retailer to purchase all materials listed below, quoting the item numbers where required

## BRONTOSAURUS EMBROIDERY

### DMC Stranded Cotton embroidery thread

**Colour A:** 3834 (purple) x 1 skein

**Colour B:** 0092 (green) x 1 skein

**Colour C:** 340 (lilac) x 1 skein

**Colour D:** 3836 (pink) x 1 skein

**Colour E:** 0052 (blue) x 1 skein

15.5cm embroidery hoop  
(item no. MK0025)

25 x 25cm Tissu de Marie purple batik fabric  
(item no. 706020-22)

1 sheet lilac felt for backing  
(item no. 10100-039)

1 spool Gütermann C NE 50 lilac thread  
(item no. GNE50-6182)

Prym Fray Check  
(item no. 968.020)

1 x crewel embroidery needle  
(item no. 125.542)

Water-soluble pen  
(item no. 611.808)





# Terry Triceratops

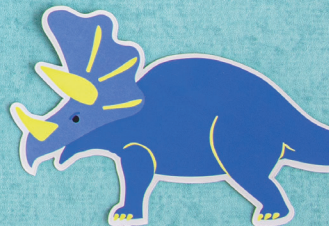

For you and your mini-me!  
This fun and fast make  
can be made for any age



## TRICERATOPS HOODED SHAWL



By Hedy Kunst-Drost

### Gauge/Tension

13 sts and 6 rows to measure 10 x 10cm over tr using a 5mm hook

### Measurements

Hood when laid flat: 35cm high x 40cm wide  
Scarf when laid flat: 130cm long x 15cm wide with 15cm deep pockets on either side

### Abbreviations (UK Terms)

[ ] number of sts on a given row/round

**ch-1 sp(s)** chain 1 space(s); number denotes number of chains in chain space

**ch(s)** chain(s) or chain st(s)

**dc** double crochet

**htr** half treble crochet

**mr** magic ring

**rep** repeat

**RS** right side

**ss** slip stitch(es)

**st(s)** stitch(es)

**tr** treble stitch(es)

**tr2tog** treble crochet 2 together to decrease by 1 st: (yoh, insert hook in next st/sp, yoh, pull up loop, yoh, draw through 2 loops) twice, yoh, draw through all loops

**tr6tog** treble crochet 6 together to decrease by 5 sts: (yoh, insert hook in next st/sp, yoh, pull up loop, yoh, draw through 2 loops) 6 times, yoh, draw through all loops

**yoh** yarn over hook

**WS** wrong side

**(.....) x times** work the instructions between brackets the *total* number of times stated

### Pattern Notes

Scarf and Hood are worked back and forth in rows, turning after each row, and finished with Border. Hood is then attached to Scarf, and joined together at top to create Hood shape. Collar and Horns are then attached to Hood, and Pockets to RS of Scarf at each end. Claws decorate ends of Pockets.

Beg ch(s) **do not** count as st(s) throughout. For Border rounds, work 7dc per 4 rows of tr evenly along edge.

Suitable for children 4-6 years old, or teens and adults with adaptations (see page 10).

### Instructions

#### SCARF

Using 6mm hook and Yarn A, ch18. Change to 5mm hook.

**Row 1 (RS)** 1tr in fourth ch from hook (skipped 3 chs do not count as st), 1tr in each ch to end, turn. [15 sts]

**Rows 2 (WS)-68** Ch3, 1tr in each st, turn. [15 sts]

#### Rounded End of Scarf

**Row 1 (RS)** Ch3, tr2tog, 1tr in each st to last 2 sts, tr2tog, turn. [9 sts]

**Row 2 (WS)-3** Rep Row 1.

**Row 4** Ch3, (tr2tog) twice, 1tr, (tr2tog) twice. [5 sts]

**Row 5** Ch1, 1dc, 1htr, 2tr in next st, 1htr, 1dc. [6 sts]  
Fasten off.

PRETTY LITTLE THINGS



### SHOPPING LIST

Visit your local Scheepjes retailer to purchase all materials listed below, quoting the item numbers where required

## TRICERATOPS HOODED SHAWL

### Scheepjes Chunky Monkey

(100% Premium Acrylic (Anti Pilling); 100g/116m)

**Yarn A:** 1019 Powder Blue x 4 balls

**Yarn B:** 1003 Cornflower Blue x 1 ball

**Yarn C:** 1001 White x 1 ball

5mm and 6mm crochet hooks

3 x stitch markers

Polyester stuffing



# PRETTY LITTLE THINGS



## NOTES

Use this space to write your pattern notes!

## MAKE A MATCHING SET

This children's pattern is **easy to adapt** for teens and adults. The generous size of the Hood means you only need to make the **Scarf section longer** by simply adding rows to reach your desired length. This way, you can create this cosy accessory **for the whole family!** You may require additional yarn.

Join Yarn A with ss to other end of Scarf and work along other side of foundation chs.  
Rep Rows 1-5 of Rounded End of Scarf.

### Border

*Note: work 7dc per 4 rows of tr.*

**Round 1 (RS)** Using 5mm hook, join Yarn A with ss to Scarf edge, ch1, work dc evenly around, ss to first dc to join, **do not** turn.

**Round 2 (RS)** Ch1, 1dc in each st around, ss to first dc, fasten off.

### POCKET (MAKE 2)

Using 6mm hook and Yarn A, ch18. Change to 5mm hook.

**Row 1 (RS)** 1tr in fourth ch from hook (skipped 3 chs do not count as st), 1tr in each ch to end, turn. [15 sts]

**Rows 2 (WS)-5** Ch3, 1tr in each st to end, turn.

### Rounded End of Pocket

**Rows 6-8** Ch3, tr2tog, 1tr in each st to last 2 sts, tr2tog. [9 sts]

**Row 9** Ch3, (tr2tog) twice, 1tr, (tr2tog) twice. [5 sts]

**Row 10** Ch1, 1dc, 1htr, 2tr in next st, 1htr, 1dc. [6 sts]  
Fasten off.

### Border

*Note: work 7dc per 4 rows of tr.*

**Round 1 (RS)** Using 5mm hook, join Yarn A with ss to Pocket edge, ch1, work dc evenly around, work (1dc, ch2, 1dc) in corners at top, ss to first dc to join, **do not** turn.

**Round 2 (RS)** Work dc evenly around, work (1dc, ch2, 1dc) in ch-2 sps, ss to first dc.  
Fasten off, attach Pocket to end of Scarf.

### CLAW (MAKE 8)

Using 5mm hook and Yarn C, make mr. This section is worked using the amigurumi method.

**Round 1 (RS)** 6dc into ring. [6 sts]

**Round 2 (RS)** 1dc in each st around. [6 sts]

**Round 3** (1dc, 2dc in next st) 3 times, ss to first dc to close. [9 sts]  
Fasten off.

Stuff Claws and attach four to each Pocket.

### HOOD

Fold Scarf in half and place st marker at centre point. Count 25 sts from this marker on both sides and place additional markers to indicate position of Hood.

Using 5mm hook, join Yarn A with ss to Scarf at st marker on far right.

**Row 1 (RS)** Ch3, 1tr in each st to final st marker, turn. [50 sts]

*Move centre st marker up as you go to mark centre of Hood for shaping.*

**Rows 2 (WS)-16** Ch3, 1tr in each st, turn. [50 sts]

**Rows 17-20** Ch3, 1tr in each st to 2 sts before st marker, (tr2tog) twice, 1tr in each st to end. [42 sts]

**Row 21** Ch3, 1tr in each st to 3 sts before st marker, tr6tog, 1tr in each st to end. [37 sts]  
Fasten off, join seam at top of Hood.

### Edging

Using 5mm hook, join Yarn A with ss to front edge of Hood.

**Row 1 (RS)** Work dc evenly across front of Hood to end, end row with ss in Scarf, fasten off.



## HORN (MAKE 2)

Using 5mm hook and Yarn C, make mr. This section is worked using the amigurumi method.

**Round 1 (RS)** 6dc into ring. [6 sts]

**Round 2 (RS)** 6dc. [6 sts]

**Round 3** (1dc, 2dc in next st) 3 times. [9 sts]

**Round 4** 9dc. [9 sts]

**Round 5** (2dc, 2dc in next st) 3 times. [12 sts]

**Round 6** (Dc2tog) twice, 3dc, 2dc in next 2 sts, 3dc. [12 sts]

**Rounds 7-12** 12dc. [12 sts]

**Round 13** 12dc, ss to first dc to join. [12 sts]

Fasten off. Stuff Horns and attach to Hood.

## COLLAR (MAKE 2)

Using 6mm hook and Yarn B, ch44.

Change to 5mm hook.

**Row 1 (RS)** 1tr in fourth ch from hook (skipped 3 chs do not count as st), 40tr, turn. [41 sts]

**Row 2 (WS)** Ch3, (6tr, 3tr in next st) 5 times, 6tr, turn. [51 sts]

## Schematic 1: Garment Measurements

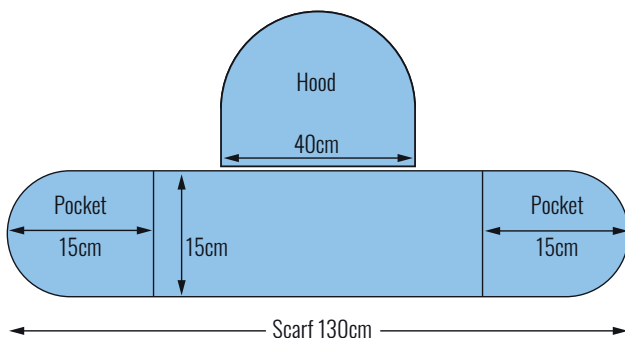

**Row 3** Ch3, 7tr, 3tr in next st, (8tr, 3tr in next st) 4 times, 7tr. [61 sts]

**Row 4** Ch3, 8tr, 3tr in next st, (10tr, 3tr in next st) 4 times, 8tr. [71 sts]

Fasten off.

Work second Collar.

Place both Collar pieces WS together and using 5mm hook, join Yarn B with ss to bottom corner on right-hand side and join together as follows:

**Round 5 (RS)** Ch1, 7dc evenly across side, ch6, 1ss in fourth ch, 2tr in next st, 1hr, 6dc, (1hr, (2tr, ch3, 1ss in first ch, 2tr) in next st, 1hr, 10dc) 4 times, 1hr, (2tr, ch3, 1ss in first ch, 2tr) in next st, 1hr, 6dc, 1hr, 2tr in next st, ch3, 1s in first ch, ch3, 7dc evenly across side. Fasten off. Attach Collar to Hood, behind Horns.

## TO FINISH

Weave in all ends. Block to measurements.



## AMAZING DINO FACTS

Do you know your dinosaurs?

Brush up on some trivia in between crafting sessions!

- 1 Like the *Brontosaurus* on page 5, the vast majority of these mighty dinosaurs were plant eaters.
- 2 Before they went extinct about 65 million years ago, there were more than 700 species of dinosaur.
- 3 One of the biggest dinosaurs to roam our planet was the *Argentinosaurus*, weighing up to 100 tonnes (around the same as 15 elephants!).
- 4 Lizards, turtles, snakes and crocodiles are all direct descendants of these fascinating creatures.
- 5 The *Micropachycephalosaurus* may have the longest dino name, but it means 'tiny, thick-headed lizard'.

# PRETTY LITTLE THINGS

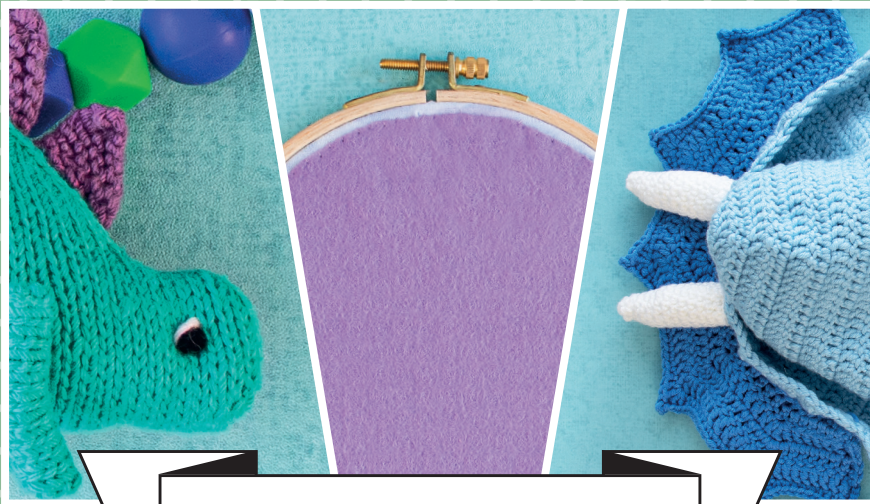

CHECK OUT THE SCHEEPJES WEBSITE  
FOR MORE FUN PATTERNS!

© [WWW.SCHEEPJES.COM](http://WWW.SCHEEPJES.COM)

For errata information please visit:  
[www.scheepjes.com/en/errata](http://www.scheepjes.com/en/errata)

